



E18-MS1PA1-IPX User Manual

CC2530 2.4GHz ZigBee 100mW SMD Wireless Module



Contents

| | |
|--|----|
| 1 General Introduction | 2 |
| 1.1 Brief Introduction | 2 |
| 1.3 Application | 2 |
| 2 Specification and parameter | 3 |
| 2.1 limit parameter | 3 |
| 2.2 Operating parameter | 3 |
| 3 Size and pin definition | 4 |
| 4 Usage | 5 |
| 5 Programming | 7 |
| 5.1 TI ZigBee FAQ | 7 |
| 6 Basic operation | 10 |
| 6.1 Hardware design | 10 |
| 6.2 Programming | 11 |
| 7 FAQ | 11 |
| 7.1 Communication range is too short | 11 |
| 7.2 Module is easy to damage | 12 |
| 7.3 BER(Bit Error Rate) is high | 12 |
| 8 Production guidance | 12 |
| 8.1 Reflow soldering temperature | 12 |
| 8.2 Reflow soldering curve | 13 |
| 9 E18 series | 13 |
| 10 Antenna recommendation | 13 |
| 10.1 Recommendation | 13 |
| 11 Package | 14 |
| Revision history | 15 |
| About us | 15 |

1 General Introduction

1.1 Brief Introduction

E18-MS1PA1-IPX is small-sized 2.4GHz SMD wireless module, which is designed and produced by Chengdu Ebyte. The space between each pin is 1.27mm. E18-MS1-IPX has been put into stable bulk production, it is applicable for various applications (especially smart home).

E18-MS1PA1-IPX adopts the original CC2530 RF chip of TI, the chip is integrated with 8051 MCU and wireless transceiver. The chip integrates 8051 MCU and wireless transceiver, and built-in CC2592 RF range extender with integrated PA+LNA, greatly expanding communication distance and improving communication stability. The module is applicable for ZigBee design and 2.4GHz IEEE 802.15.4 protocol. All IO ports of the MCU have been pinned out for multiple development.

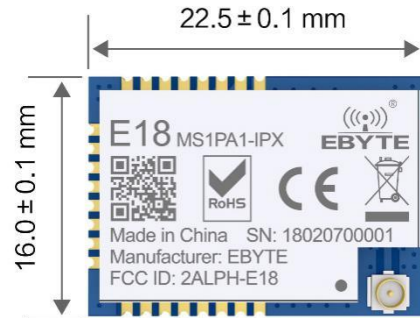

1.2 Features

- The measured communication distance is up to 1000 m;
- Maximum transmission power of 100mW, software multi-level adjustable;
- Built-in ZigBee protocol stack;
- Factory-installed self-organizing network firmware, ready to use;
- Support peripherals such as ADC, PWM, GPIO;
- Support UART transparent transmission, easy to use;
- Built-in 32.768kHz clock crystal oscillator;
- Support the global license-free ISM 2.4GHz band;
- Rich resources, 256KB FLASH, 8KB RAM;
- Built-in CC2592 RF range extender with integrated PA+LNA;
- Support 2.0V~3.6V power supply, power supply over 3.3V can guarantee the best performance;
- Industrial grade standard design, support -40 ~ 85 °C for working over a long time;
- IPEX interface for easy connection to coaxial cable or external antenna.

1.3 Application

- Smart homes and industrial sensors;
- Security system, positioning system;
- Wireless remote control, drone;
- Wireless game remote control;
- Health care products;
- Wireless voice, wireless headset;
- Automotive industry applications.

2 Specification and parameter

2.1 limit parameter

| Main parameter | Performance | | Remark |
|----------------------------|-------------|-----|---|
| | Min | Max | |
| Power supply (V) | 0 | 3.6 | Voltage over 3.6V will cause permanent damage to module |
| Blocking power (dBm) | - | 10 | Chances of burn is slim when modules are used in short distance |
| Operating temperature (°C) | -40 | 85 | - |

2.2 Operating parameter

| Main parameter | | Performance | | | 备注 |
|-----------------------------|--------------------|-------------|-------|-------|---|
| | | Min | Type | Max | |
| Operating voltage (V) | | 2.0 | 3.3 | 3.6 | ≥3.3 V ensures output power |
| Communication level (V) | | - | 3.3 | - | For 5V TTL, it may be at risk of burning down |
| Operating temperature (°C) | | -40 | - | 85 | Industrial grade |
| Operating frequency (GHz) | | 2.400 | - | 2.480 | Support ISM band |
| Power Consu m-ption | TX current (mA) | - | 140 | - | Instant power consumption |
| | RX current (mA) | - | 42 | - | - |
| | Sleep current (µA) | - | 1.2 | - | Shut down by software |
| Max TX power (dBm) | | 19.6 | 20.0 | 20.5 | - |
| Receiving sensitivity (dBm) | | -96.5 | -97.6 | -98.5 | Air data rate is 250 kbps |

| Main parameter | Description | 备注 |
|--------------------|----------------------|--|
| Reference distance | 1000 m | Test condition: clear and open area, antenna gain: 5dBi, antenna height: 2.5m, air data rate: 250 kbps |
| Protocol | ZigBee | - |
| Package | SMD | - |
| Interface | 1.27mm | - |
| IC | CC2530F256RHAT/QFN40 | Built-in CC2592 RF range extender with integrated PA+LNA |
| FLASH | 256 KB | - |
| RAM | 8 KB | - |
| Core | 8051microcontroller | - |

| | | |
|----------------|----------------|------------------|
| Main parameter | 16.0 * 22.5 mm | - |
| Antenna | IPEX | 50 ohm impedance |

3 Size and pin definition

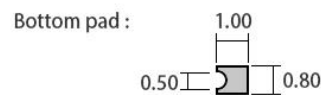
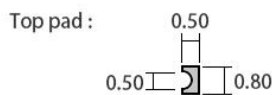
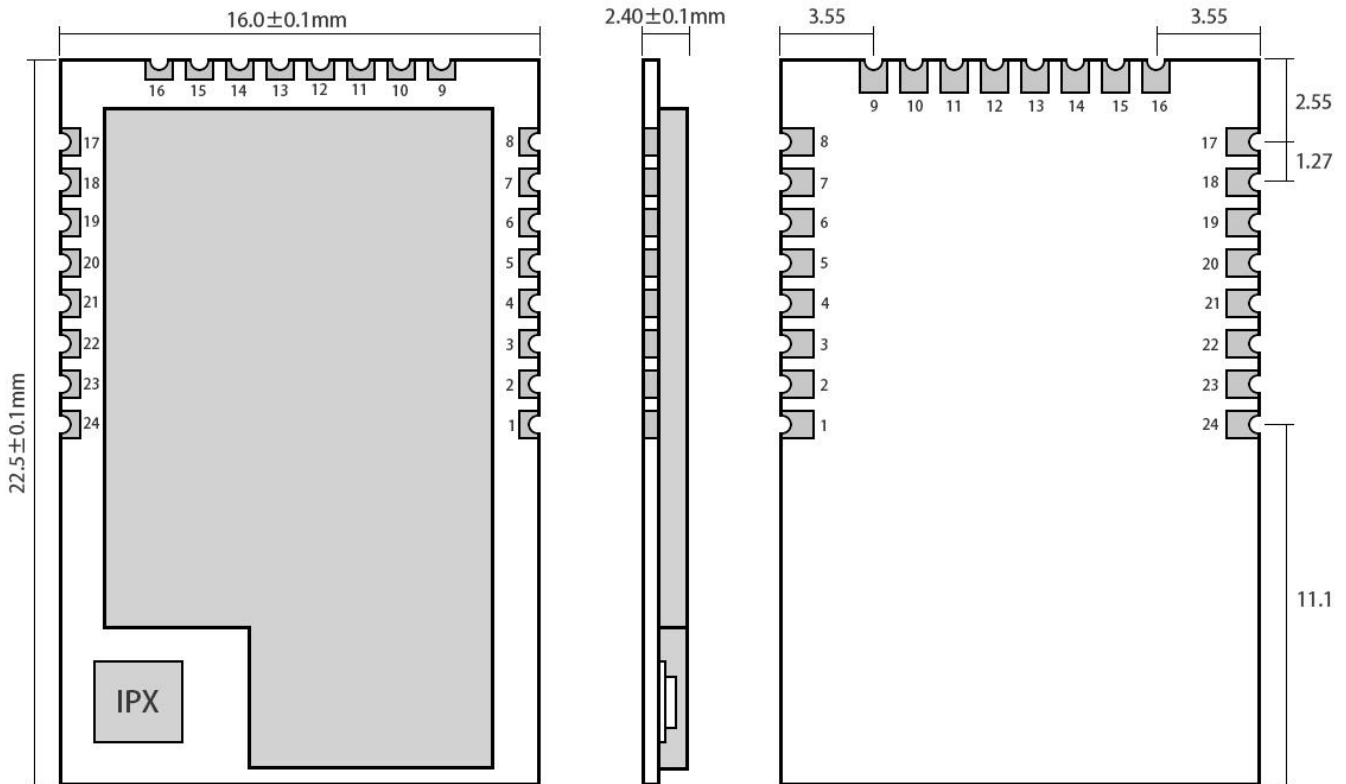

Pad quantity : 24
Unit: mm

| Pin No. | Pin item | Pin direction | Application |
|---------|----------|---------------|---|
| 1 | GND | Input | Ground, connecting to power source referential ground |
| 2 | VCC | Input | Power supply, must be 2.0 ~ 3.6V |
| 3 | P2.2 | Input/Output | MCU GPIO |
| 4 | P2.1 | Input/Output | MCU GPIO |
| 5 | P2.0 | Input/Output | MCU GPIO |
| 6 | P1.7 | Input/Output | MCU GPIO |
| 7 | P1.6 | Input/Output | MCU GPIO |
| 8 | NC | - | Reserved |
| 9 | NC | - | Reserved |

| | | | |
|----|-------|--------------|--|
| 10 | P1.5 | Input/Output | MCU GPIO |
| 11 | P1.4 | Input/Output | MCU GPIO |
| 12 | P1.3 | Input/Output | MCU GPIO |
| 13 | P1.2 | Input/Output | MCU GPIO |
| 14 | P1.1 | Output | MCU GPIO, PA transmitting control pin |
| 15 | P1.0 | Output | MCU GPIO, PA receiving control pin |
| 16 | P0.7 | Output | MCU GPIO, PA receiving high gain control pin |
| 17 | P0.6 | Input/Output | MCU GPIO |
| 18 | P0.5 | Input/Output | MCU GPIO |
| 19 | P0.4 | Input/Output | MCU GPIO |
| 20 | P0.3 | Input/Output | MCU GPIO |
| 21 | P0.2 | Input/Output | MCU GPIO |
| 22 | P0.1 | Input/Output | MCU GPIO |
| 23 | P0.0 | Input/Output | MCU GPIO |
| 24 | RESET | Input | Reset port |

- For the IO function, please go to the official website to download "E18_Software_Datasheet_CN";
- For secondary development, please refer to TI's official "CC2530 Datasheet" for pin definition, software driver and communication protocol.

4 Usage

| No. | Keyword | Remark |
|-----|---------------|--|
| 1 | Burn firmware | <p>The module is with built-in 8051 MCU, to download program please use downloader CC Debugger</p> |
| 2 | Initiate PA | Initiate PA , modify it in file hal_board_cfg.h. |

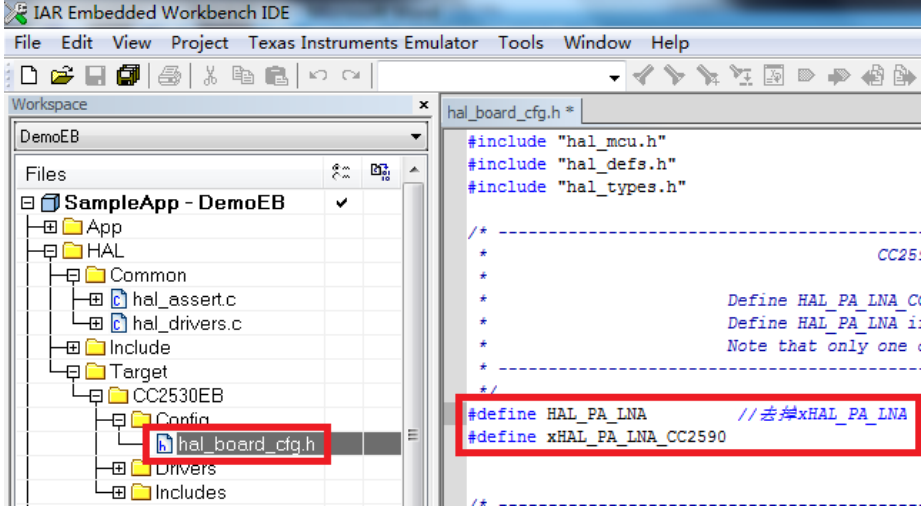
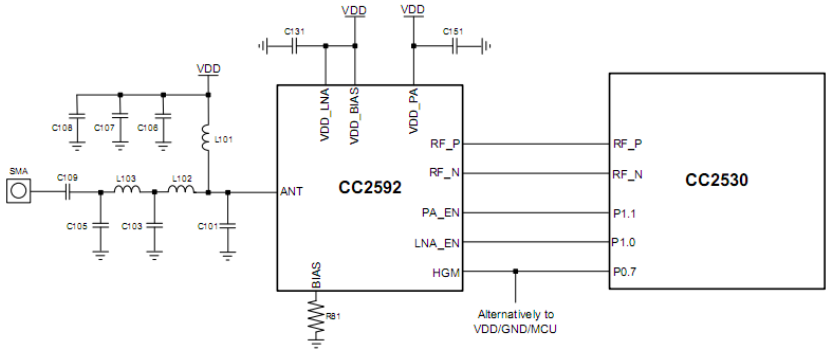
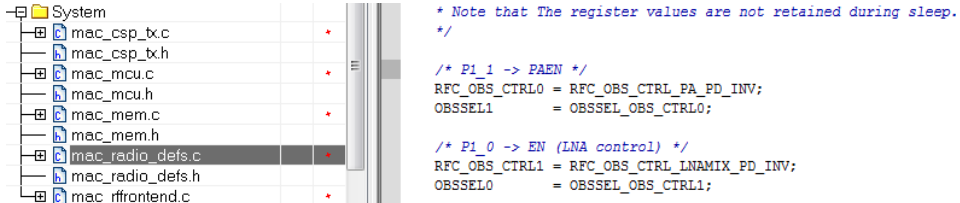
| | |  <pre> #include "hal_mcu.h" #include "hal_defs.h" #include "hal_types.h" /* ----- * * CC25 * * Define HAL_PA_LNA_C * Define HAL_PA_LNA i * Note that only one * ----- */ #define HAL_PA_LNA // #xHAL_PA_LNA #define xHAL_PA_LNA_CC2590 </pre> | | | | | | | | | | | | | | | | | | | | |
|----------|-----------------------------|--|-------------------|--------|-----|-------------------|---|---|---|------------|---|---|---|------------------|---|---|---|-------------------|---|---|---|----|
| <p>3</p> | <p>Parameter setting</p> | <p>The setting of CC2592 in zstack, CC2530 pin: P1.1、P1.0、P0.7 are connected with CC2592 pin :PA_EN、LNA_EN、HGM. Meanwhile, LNA_EN is in high level,and it is in receiving mode.</p> <p>Table 9-1 shows the control logic for connecting CC2592 to a CC25xx device.</p> <p>Table 9-1. Control Logic for Connecting CC2592 to a CC25xx Device</p> <table border="1" data-bbox="630 1012 1257 1122"> <thead> <tr> <th>PA_EN</th> <th>LNA_EN</th> <th>HGM</th> <th>Mode of Operation</th> </tr> </thead> <tbody> <tr> <td>0</td> <td>0</td> <td>X</td> <td>Power Down</td> </tr> <tr> <td>X</td> <td>1</td> <td>0</td> <td>RX Low-Gain Mode</td> </tr> <tr> <td>X</td> <td>1</td> <td>1</td> <td>RX High-Gain Mode</td> </tr> <tr> <td>1</td> <td>0</td> <td>X</td> <td>TX</td> </tr> </tbody> </table> <p>Figure 9-1 shows the application circuit for the CC2592 and CC253X devices.</p>  <p>Figure 9-1. Application Circuit Example for CC2530 + CC2592</p> | PA_EN | LNA_EN | HGM | Mode of Operation | 0 | 0 | X | Power Down | X | 1 | 0 | RX Low-Gain Mode | X | 1 | 1 | RX High-Gain Mode | 1 | 0 | X | TX |
| PA_EN | LNA_EN | HGM | Mode of Operation | | | | | | | | | | | | | | | | | | | |
| 0 | 0 | X | Power Down | | | | | | | | | | | | | | | | | | | |
| X | 1 | 0 | RX Low-Gain Mode | | | | | | | | | | | | | | | | | | | |
| X | 1 | 1 | RX High-Gain Mode | | | | | | | | | | | | | | | | | | | |
| 1 | 0 | X | TX | | | | | | | | | | | | | | | | | | | |
| <p>4</p> | <p>Program modification</p> | <p>Find macRadioTurnOnPower() from mac_radio_defs.c, and modify.</p>  <pre> /* Note that The register values are not retained during sleep. */ /* P1_1 -> PAEN */ RFC_OBS_CTRL0 = RFC_OBS_CTRL_PA_PD_INV; OBSSEL1 = OBSSEL_OBS_CTRL0; /* P1_0 -> EN (LNA control) */ RFC_OBS_CTRL1 = RFC_OBS_CTRL_LNAMIX_PD_INV; OBSSEL0 = OBSSEL_OBS_CTRL1; </pre> | | | | | | | | | | | | | | | | | | | | |

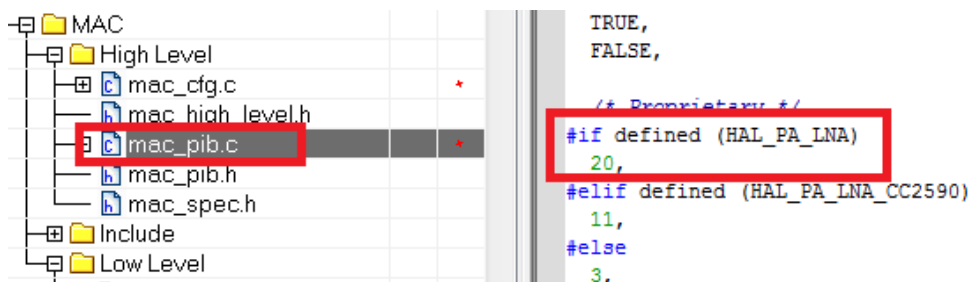
| | | |
|---|----------------------------|--|
| 5 | Power modificati -on | <p>Find static CODE const macPib_t macPibDefaults from file mac_pib.c. Modify in the red signed below.</p>  <pre> TRUE, FALSE, /* Proprietary */ #if defined (HAL_PA_LNA) 20, #elif defined (HAL_PA_LNA_CC2590) 11, #else 3, </pre> |
|---|----------------------------|--|

5 Programming

You are recommended to use the Code Composer Studio (CCS) integrated development environment (IDE) applicable for wireless.

Code Composer Studio is a kind of IDE, it supports TI MCU and embedded processor series products. Code Composer Studio covers a whole set of tools for development and embedded application. It covers the C/C++ compiler for optimizing, source code editor, project building environment, debugger, descriptor and many other functions. The IDE provides individual user interface, it can help you complete every step in developing. Familiar tool and interface enables users to start more quickly. Code Composer Studio integrates the advantages of Eclipse software frame and the embedded debugging function of TI and provides a knockout and functionable development environment.

5.1 TI ZigBee FAQ

How to select proper protocol stack from different ZigBee protocol stacks of TI?

From the Z-Stack 0.1 to Z-Stack 2.5.1a and the current Z-Stack Home 1.2.1, Z-Stack Lighting 1.0.2, Z-Stack Energy 1.0.1, Z-Stack Mesh 1.0.0, TI mainly upgraded the protocol stack through: 1) adding some new features according to ZigBee Specification of the ZigBee Alliance, for example, ZigBee2007 tree-shape route, adding Mesh route in ZigBee Pro, and raising MTO and Source Routing algorithms so TI added some new functions to the protocol stack, also did some correction of bugs in Spec such as some unclear descriptions; 2) Correction of bugs of TI ZigBee protocol itself. You can find the differences between one protocol stack and the previous version in the Release Note of the installation directory.

After the Z-Stack 2.5.1a, TI did not publish the protocol stack in the form of Z-Stack 2.6.x but in Application Profile form, because TI hopes the developers could select proper protocol stack based on actual applications. The protocol stacks like Z-Stack Home 1.2.1 includes two parts: 1) Core Stack, it is the follow-up versions of Z-Stack 2.5.1a, it can be found from the Z-Stack Core Release Notes.txt, Version 2.6.2. 2) Profile-related part, this part is related to the actual application, Home Automation stack is about the realization of ZigBee Home Automation Profile. Meanwhile, Z-Stack Lighting 1.0.2 and Z-Stack Energy 1.0.1 are Core Stack with Profile for application.

- 1) Z-Stack Home 1.2.2a is specific for smart home products development.
- 2) Z-Stack Lighting 1.0.2 is specific for ZLL products development.
- 3) Z-Stack Energy 1.0.1 is specific for intelligent energy, meter, In Home Display, and so on.

4) Z-Stack Mesh 1.0.0 is specific for private applications, it only utilizes the function of standard ZigBee protocol, Mesh route and so on, the application layer shall be defined by the developer.

After the publish of ZigBee 3.0 protocol, the latest ZigBee protocol stack is Z-Stack 3.0, it supports CC2530 and CC2538.

How to apply for standard ZigBee test certification?

Take standard ZigBee Home Automation products as example, developers must develop according to the description in the ZigBee Home Automation Profile Specification, this document can be found from www.zigbee.or. After developing the product, developers need to learn the ZigBee Home Automation Profile Test Specification, this document described the items to be tested by the Test House, it can be downloaded from www.zigbee.org also, in addition, there is another PICS document, it is specific for describing the functions supported, developers confirm the functions by checking the boxes according to the actual functions and the required functions in the Specification, as below are the testing procedure:

- 1) Join the ZigBee alliance, generally assisted by testing labs;
- 2) Send samples to testing lab, complete the PICS file;
- 3) First round pre-testing, the testing lab feedback the testing results, developers modify the sample codes.
- 4) The testing lab verify the modified sample, and starts formal test;
- 5) The testing lab assists developers to complete the ZigBee alliance online certification application;
- 6) The testing lab submits the test report to ZigBee alliance. The alliance will review and issue certificate.

Currently, there are two testing labs in China who can complete standard ZigBee test:

- 1) CESI in Beijing;
- 2) Element Shenzhen Office (headquartered in England)

Please refer to below wiki link for details:

http://processors.wiki.ti.com/index.php/ZigBee_Product_Certification_Guide

How to select the 64-bit MAC address of the device?

There are two IEEE addresses in CC2530/CC2538/CC2630, one is Primary IEEE address, the other is Secondary address. Primary IEEE address is stored in Information Page of the chip, this address is bought by TI from IEEE, each chip has one unique address. Users could only Read this value and cannot modify or erase it. By reading the address in the protocol stack, users can obtain `osal_memcpy(aExtendedAddress, (uint8 *) (P_INFOPAGE+HAL_INFOP_IEEE_OSET), Z_EXTADDR_LEN)`. Secondary address is stored in the last Page of the Flash of CC2530, users can Read/Write with the function `HalFlashRead (HAL_FLASH_IEEE_PAGE, HAL_FLASH_IEEE_OSET, aExtendedAddress, Z_EXTADDR_LEN)`.

When the protocol stack is operating, how to select Primary IEEE address or Secondary address as MAC address? Please operate in the function `zmain_ext_addr(void)`.

- 1) Read IEEE address from NV, if it already exists (not 0xFF), use this address as MAC address;
- 2) If not in 1), read from the Secondary IEEE address storage place, if it exists (not 0xFF), write the address into NV, and use this address as MAC address;
- 3) If not in 2), read from the Primary IEEE address storage place, if it exists (not 0xFF), write the address into NV, and use this address as MAC address;
- 4) If not in 3), generate one 64-bit variable randomly, write it into NV, use it as MAC address.

How to forbid node from searching network, or extend the interval for sending Beacon Request?

End Device is low power consumption device powered by battery, after cutting from network, how to forbid the node from searching network, or how to extend the interval for sending Beacon Request.

- 1) Start searching network uint8 ZDApp_StartJoiningCycle(void)
 Stop searching network uint8 ZDApp_StopJoiningCycle(void)
- 2) Change the Beacon Request sending period
 Modify the variable zgDefaultStartingScanDuration

```
// Beacon Order Values
#define BEACON_ORDER_NO_BEACONS      15
#define BEACON_ORDER_4_MINUTES      14 // 245760 milliseconds
#define BEACON_ORDER_2_MINUTES      13 // 122880 milliseconds
#define BEACON_ORDER_1_MINUTE       12 // 61440 milliseconds
#define BEACON_ORDER_31_SECONDS     11 // 30720 milliseconds
#define BEACON_ORDER_15_SECONDS     10 // 15360 MSecs
#define BEACON_ORDER_7_5_SECONDS    9 // 7680 MSecs
#define BEACON_ORDER_4_SECONDS      8 // 3840 MSecs
#define BEACON_ORDER_2_SECONDS      7 // 1920 MSecs
#define BEACON_ORDER_1_SECOND       6 // 960 MSecs
#define BEACON_ORDER_480_MSEC       5
#define BEACON_ORDER_240_MSEC       4
#define BEACON_ORDER_120_MSEC       3
#define BEACON_ORDER_60_MSEC        2
#define BEACON_ORDER_30_MSEC        1
#define BEACON_ORDER_15_MSEC        0
```

How to put End Device into low power consumption mode, how to set up sleep time?

After the `POWER_SAVING` is enabled in the protocol stack macro definition, put `DRFD_RCVC_ALWAYS_ON=FALSE` in `f8wConfig.cfg` file, then the End Device will enter sleep mode.

The sleep time is decided by the OSAL operating system, the latest Event Timeout to occur will be set as sleep time. There is description in the protocol stack `hal_sleep` function.

There are two kinds of timeout: one is the timeout of application layer event, the other is the timeout of MAC layer event.

- 1) Timeout of application layer, can be obtained through `osal_next_timeout()` of `osal_pwrmgr_powerconserve(void)` function;
- 2) Timeout of MAC layer, can be obtained through `MAC_PwrNextTimeout()` of `halSleep(uint16 osal_timeout)` function.

What new features does ZigBee 3.0 stack have?

Please refer to below link, it describes the new features of the ZigBee 3.0 stack as compared with the previous ZigBee Home Automation/ZigBee Light Link.

http://processors.wiki.ti.com/index.php/What%27s_New_in_ZigBee_3.0

About the status switch in the TI ZigBee protocol stack

http://www.deyisupport.com/question_answer/wireless_connectivity/zigbee/f/104/t/104629.aspx

About the difference between OAD and OTA in TI protocol stack?

OAD is short for Over the Air Download, OTA is short for Over the Air. The functions of these two are the same, they can be called the software upgrade on air. In the earlier ZigBee protocol standard, there was no standard for node software upgrading on air, but many customers have such requirements, thus TI developed their own protocol stack for software upgrading on air, and named it as OAD. After that, ZigBee alliance noticed the more and more requirements for upgrading on air, so they developed the upgrading on air standard and named it as OTA, this standard has taken the TI OAD method as reference and has made some modification. The upgrading on air in TI's earlier protocol stack, it is called OAD, and in the later stack, it is called OTA as following the ZigBee alliance stack.

Which protocol stack shall be selected for developing private application based on ZigBee Mesh?

Many customers only need to apply the function of ZigBee Mesh network in their system or products, and do not need to do according to the application layer as defined by the ZigBee, especially for some industrial applications, as for such requirements, how to select proper TI protocol stack for developing products?

http://www.devisupport.com/question_answer/wireless_connectivity/zigbee/f/104/t/132197.aspx

6 Basic operation

6.1 Hardware design

- It is recommended to use a DC stabilized power supply. The power supply ripple factor is as small as possible and the module needs to be reliably grounded;
- Please pay attention to the correct connection of the positive and negative poles of the power supply, reverse connection may cause permanent damage to the module;
- Please check the power supply to ensure that between the recommended supply voltage, if exceeding the maximum, the module will be permanently damaged;
- Please check the stability of the power supply. Voltage can not fluctuate greatly and frequently;
- When designing the power supply circuit for the module, it is often recommended to reserve more than 30% of the margin, so the whole machine is beneficial for long-term stable operation;
- The module should be as far away as possible from the power supply, transformers, high-frequency wiring and other parts with large electromagnetic interference;
- Bottom Layer High-frequency digital routing, high-frequency analog routing, and power routing must be avoided under the module. If it is necessary to pass through the module, assume that the module is soldered to the Top Layer, and the copper is spread on the Top Layer of the module contact part(well grounded), it must be close to the digital part of the module and routed in the Bottom Layer;
- Assuming the module is soldered or placed over the Top Layer, it is wrong to randomly route over the Bottom Layer or other layers, which will affect the module's spurs and receiving sensitivity to varying degrees;
- It is assumed that there are devices with large electromagnetic interference around the module that will greatly affect the performance. It is recommended to keep them away from the module according to the strength of the

interference. If necessary, appropriate isolation and shielding can be done;

- Assume that there are traces with large electromagnetic interference (high-frequency digital, high-frequency analog, power traces) around the module that will greatly affect the performance of the module. It is recommended to stay away from the module according to the strength of the interference. If necessary, appropriate isolation and shielding can be done;
- If the communication line uses a 5V level, a 1k-5.1k resistor must be connected in series (not recommended, there is still a risk of damage);
- Try to stay away from some physical layers such as TTL protocol at 2.4GHz, for example: USB3.0;
- The mounting structure of antenna has a great influence on the performance of the module. It is necessary to ensure that the antenna is exposed, preferably vertically upward. When the module is mounted inside the case, use a good antenna extension cable to extend the antenna to the outside;
- The antenna must not be installed inside the metal case, which will cause the transmission distance to be greatly weakened.

6.2 Programming

- The core of this module is CC2530, its driving method is completely equivalent to CC2530, the user can operate according to the CC2530 chip manual (see CC2530 manual for details);
- It is recommended to use the Code Composer Studio (CCS) Integrated Development Environment (IDE).
- Code Composer Studio is an integrated development environment (IDE) that supports TI's microcontroller and embedded processor products. Code Composer Studio includes a complete set of tools for developing and debugging embedded applications. It includes the C/C++ compiler, source editor, project build environment, debugger, descriptor, and many other features. The IDE provides a single user interface to help you through every step of the application development process. Familiar tools and interfaces allow users to get started faster than ever before. Code Composer Studio combines the benefits of the Eclipse software framework with TI's advanced embedded debugging capabilities to provide embedded developers with a compelling, feature-rich development environment.
 - ★ When transmitting, set DIO_7 pin to high level and DIO_13, DIO_14 pins to low level;
 - ★ When receiving, set DIO_7 pin to low level and DIO_13, DIO_14 pins to high level;
 - ★ Before turning off, set DIO_7, DIO_13, DIO_14 pins to low;
- The register configuration can be reinitialized when the chip is idle for greater stability.

7 FAQ

7.1 Communication range is too short

- The communication distance will be affected when obstacle exists;
- Data lose rate will be affected by temperature, humidity and co-channel interference;
- The ground will absorb and reflect wireless radio wave, so the performance will be poor when testing near ground;
- Sea water has great ability in absorbing wireless radio wave, so performance will be poor when testing near the sea;
- The signal will be affected when the antenna is near metal object or put in a metal case;
- Power register was set incorrectly, air data rate is set as too high (the higher the air data rate, the shorter the distance);

- The power supply low voltage under room temperature is lower than recommended value, the lower the voltage, the lower the transmitting power;
- Due to antenna quality or poor matching between antenna and module.

7.2 Module is easy to damage

- Please check the power supply source, ensure it is between the recommended supply voltage, voltage higher than the maximum will damage the module.
- Please check the stability of power source, the voltage cannot fluctuate too much;
- Please make sure antistatic measure are taken when installing and using, high frequency devices have electrostatic susceptibility;
- Please ensure the humidity is within limited range, some parts are sensitive to humidity;
- Please avoid using modules under too high or too low temperature.

7.3 BER(Bit Error Rate) is high

- There are co-channel signal interference nearby, please be away from interference sources or modify frequency and channel to avoid interference;
- Poor power supply may cause messy code. Make sure that the power supply is reliable;
- The extension line and feeder quality are poor or too long, so the bit error rate is high;

8 Production guidance

8.1 Reflow soldering temperature

| Profile Feature | Curve characteristics | Sn-Pb Assembly | Pb-Free Assembly |
|---|-----------------------------------|----------------|------------------|
| Solder Paste | Solder paste | Sn63/Pb37 | Sn96.5/Ag3/Cu0.5 |
| Preheat Temperature min (T _{smin}) | Min preheating temp. | 100°C | 150°C |
| Preheat temperature max (T _{smax}) | Max preheating temp. | 150°C | 200°C |
| Preheat Time (T _{smin} to T _{smax})(ts) | Preheating time | 60-120 sec | 60-120 sec |
| Average ramp-up rate(T _{smax} to T _p) | Average ramp-up rate | 3°C/second max | 3°C/second max |
| Liquidous Temperature (TL) | Liquid phase temp | 183°C | 217°C |
| Time (t _L) Maintained Above (TL) | Time below liquid phase line | 60-90 sec | 30-90 sec |
| Peak temperature (T _p) | Peak temp | 220-235°C | 230-250°C |
| Average ramp-down rate (T _p to T _{smax}) | Average ramp-down rate | 6°C/second max | 6°C/second max |
| Time 25°C to peak temperature | Time to peak temperature for 25°C | 6 minutes max | 8 minutes max |

8.2 Reflow soldering curve

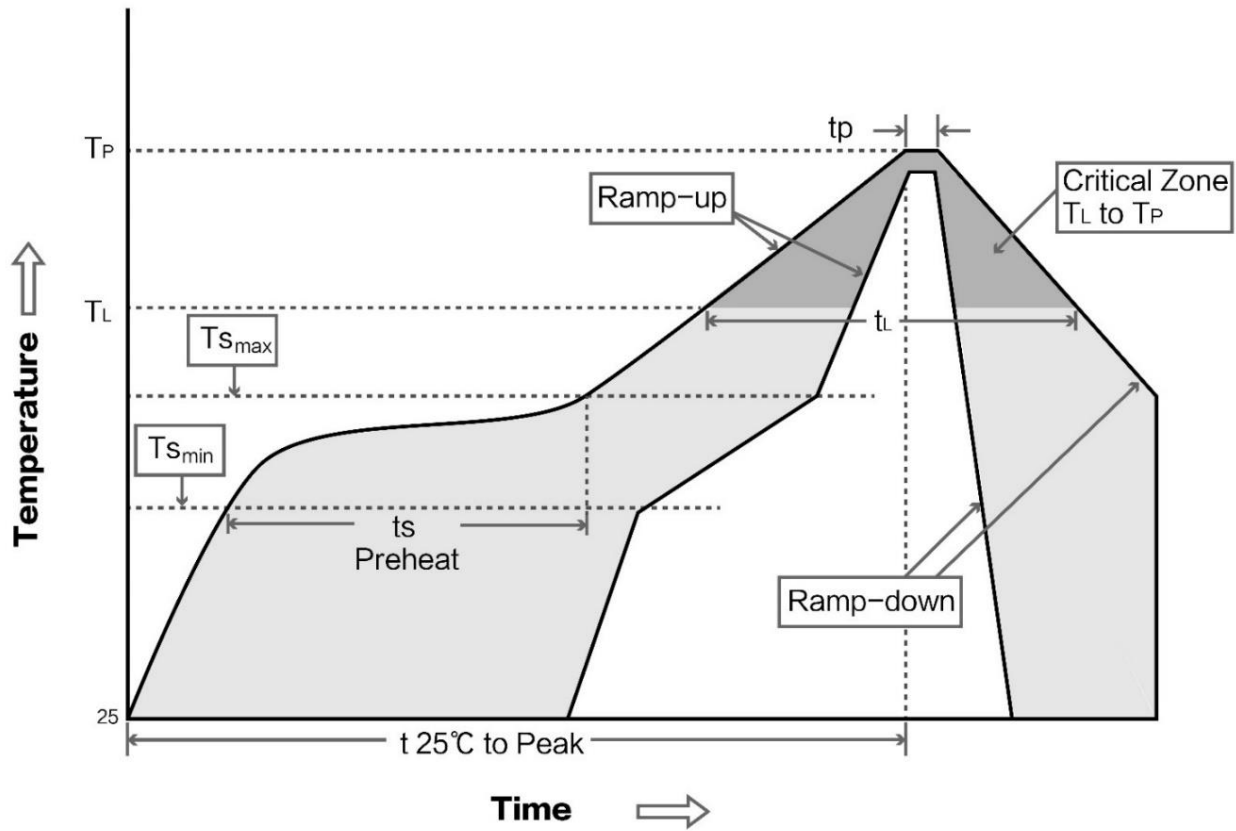

9 E18 series

| Model | IC | Frequency Hz | Tx power dBm | Distance km | Air data rate bps | Package form | Size mm | Antenna |
|--------------------------------|--------|--------------|--------------|-------------|-------------------|--------------|-------------|-------------|
| E18-MS1PA1-IPX | CC2530 | 2.4G | 20 | 1 | IPX | SMD | 16 * 22.5 | IPEX |
| E18-MS1PA1-PCB | CC2530 | 2.4G | 20 | 0.8 | PCB | SMD | 16 * 27 | PCB antenna |
| E18-MS1-IPX | CC2530 | 2.4G | 4 | 0.24 | IPX | SMD | 14.1 * 20.8 | IPEX |
| E18-MS1-PCB | CC2530 | 2.4G | 4 | 0.2 | PCB | SMD | 14.1 * 23 | PCB antenna |

10 Antenna recommendation

10.1 Recommendation

The antenna is an important role in the communication process. A good antenna can largely improve the communication system. Therefore, we recommend some antennas for wireless modules with excellent performance and reasonable price.

| Model No. | Type | Frequency Hz | Interface | Gain dBi | Height | Cable | Function feature |
|-----------|------|--------------|-----------|----------|--------|-------|------------------|
|-----------|------|--------------|-----------|----------|--------|-------|------------------|

| | | | | | | | |
|--------------------------------|------------------|------|-------|-----|---------|-------|---------------------------------|
| TX2400-NP-5010 | Flexible Antenna | 2.4G | IPEX | 2 | 50*10mm | - | FPC soft antenna |
| TX2400-XP-150 | Sucker antenna | 2.4G | SMA-J | 3.5 | 15cm | 150cm | High Gain |
| TX2400-JK-20 | Rubber antenna | 2.4G | SMA-J | 3 | 200mm | - | Flexible&omnidirectional |
| TX2400-JK-11 | Rubber antenna | 2.4G | SMA-J | 2.5 | 110mm | - | Flexible&omnidirectional |
| TX2400-JZ-3 | Rubber antenna | 2.4G | SMA-J | 2 | 30mm | - | Short straight &omnidirectional |

11 Package

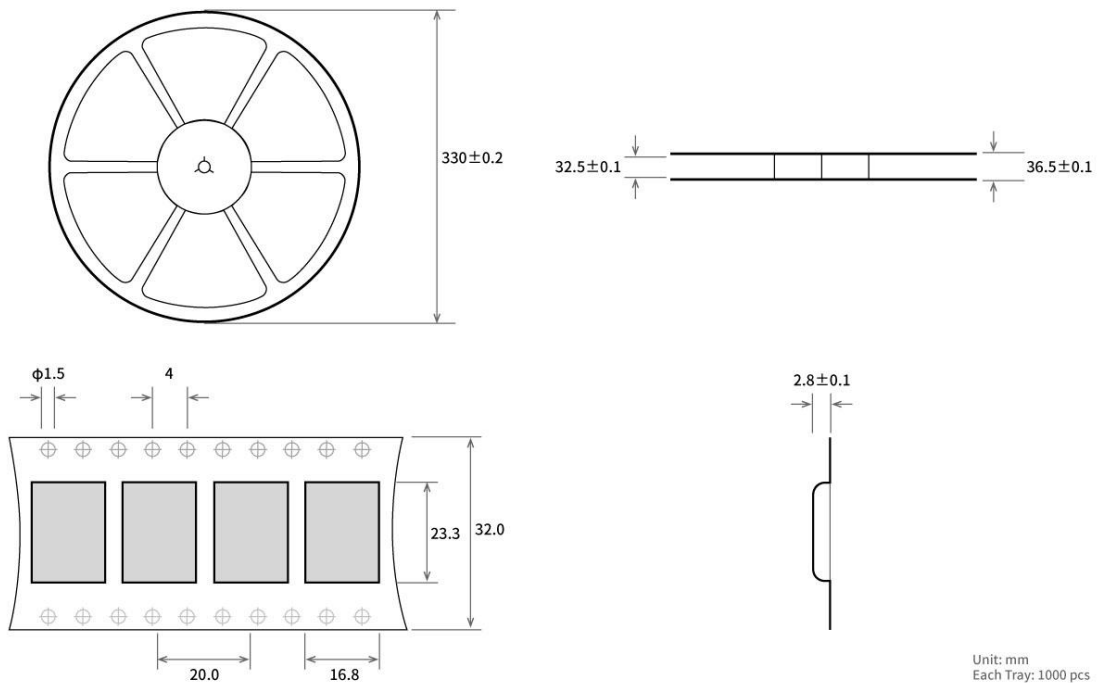

Revision history

| Version | Date | Description | Issued by |
|---------|------------|-----------------|-----------|
| 1.00 | 2018/8/30 | Initial version | huaa |
| 1.10 | 2018/11/08 | Model No. split | huaa |

About us

Technical support: support@cdebyte.com

Documents and RF Setting download link: www.ebyte.com

Thank you for using Ebyte products! Please contact us with any questions or suggestions: info@cdebyte.com

Official hotline:028-61399028 ext. 821

Web: www.ebyte.com

Address: Innovation Center D347, 4# XI-XIN Road, Chengdu, Sichuan, China



Chengdu Ebyte Electronic Technology Co.,Ltd.