

### RS485

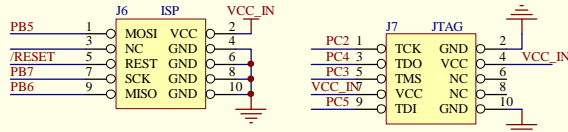

### Module LCD

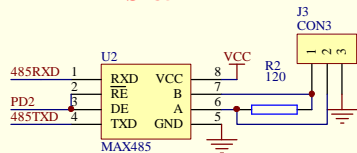
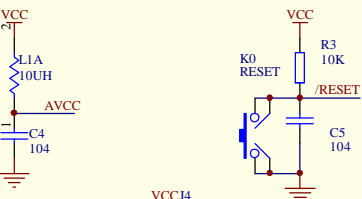
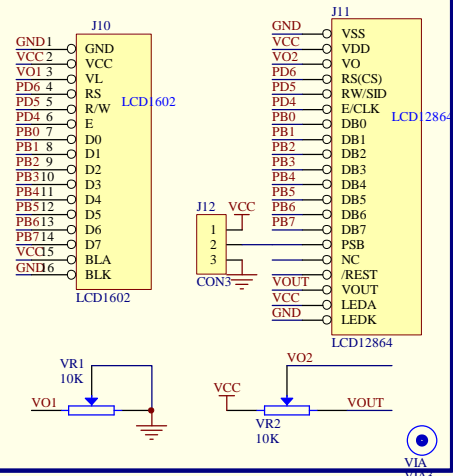

### 4 Nút nhấn độc lập

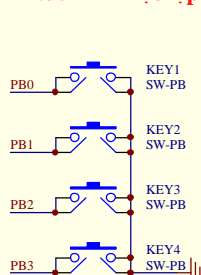

### Bộ dao động

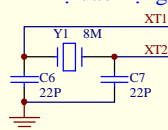

### Cảm biến nhiệt độ

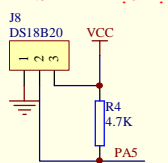

Title		
Size	Number	Revision
A4		
Date:	8-Jan-2013	Sheet of
File:		